





NEWS



COMET

SERIE S. 32



800 SERIES DRUM THRONES

S. 46



VENUS
UPDATE S. 28



ARMORY
NEUE FARBEN

S. 20



600 SERIES
DRUM THRONES

S. 47



SATURN

EVOLUTION

SO YOU THINK YOU KNOW SATURN? THINK AGAIN.

Saturn Evolution – die Evolution der Innovationen

Maple / Walnut / Maple | Birch / Walnut / Birch | Hybrid Kombinationen |
ein brandneues „HALO“ Mounting System | revolutionäre Design Lab Features
...und das **Saturn Evolution** ist geboren.



Kesselkompositionen

Es sind zwei Kompositionen erhältlich:

Saturn Maple: Maple/Walnut/Maple – hell, vielseitig, offen

Saturn Birch: Birch/Walnut/Birch – dunkel, punchy, trocken

Die Kesselkomposition lässt sich am Badge klar identifizieren.

HALO Mounting System

Die vier diagonal angeordneten Kontaktpunkte entlasten komplett den Kessel und verhindern eine ungewollte Dämmung durch den Druck des Eigengewichts.

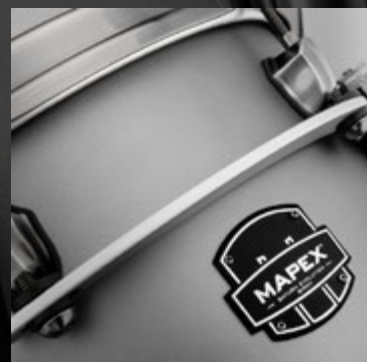

Chamber Specific Design

Die Holzlagen werden bei größerem Kesseldurchmesser dicker und die Gratung wird jeweils entsprechend angepasst. Dieses Detail sorgt für eine Symphonie ideal aufeinander abgestimmter Kessel, die in Kombination ein perfektes Drumset darstellen.

SAS Static 90° Floor Tom Leg

Umso gerader das Bein, desto größer der Soundverlust:
Das 90° Design Lab Floortom Bein löst genau dieses Problem.



SAS Sonic Pedestal Foot

Die Konstruktion des Fußes verhindert den direkten Kontakt zum Boden, was die Floortom auf der Gummifeder zum „schweben“ bringt. Das eliminiert den Verlust durch Vibrationsübertragung und maximiert die Kesselresonanz.

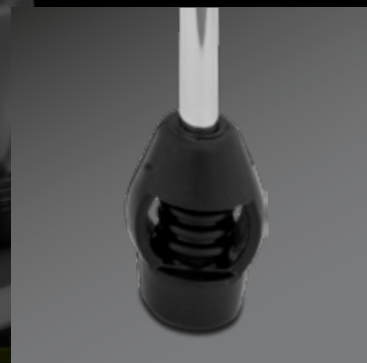

Floor Tom Isolation Gaskets

Alle Metallteile der Floortomhalterungen befinden sich vollständig an der Außenseite des Kessels und sind durch eine spezielle Gummiluftdichtung isoliert. Dadurch wird der gesamte Druck vom Kessel genommen und der Vibrationsverlust maximal verringert.

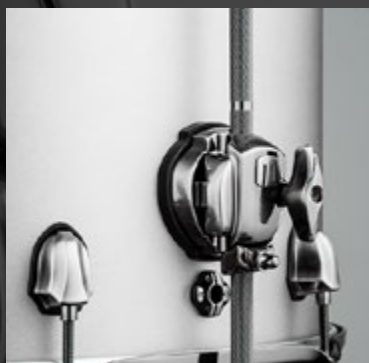

Air Flow Venting

Die Ventilation ist der Schlüssel zum Spielgefühl und der Eigenresonanz des Kessels. Bei ausführlichen Tests bei den Design Lab Drums wurde nach einer Formel für die ideale Anzahl von Luftlöchern geforscht. Diese werden an der „Nodal Line“ zusammen mit den Böckchen angebracht, um die Resonanz des Kessels nicht negativ zu beeinflussen.

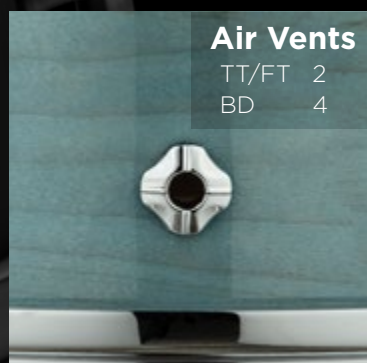

SAS Scale Finishes

SAS 0

Hat einen sehr geringen bis keinen Einfluss auf den Sound des Kessels.

SAS 1

Hat einen geringen Einfluss auf den Sound des Kessels.

SAS 2

Hat einen signifikanten Einfluss auf den Sound des Kessels.





SATURN

EVOLUTION | EXOTIC FINISHES



EXOTIC AEGEAN FADE [OE]

Chrome Hardware

SAS 2



EXOTIC NIGHT FOREST BURST [MZ]

Black Brushed Hardware

SAS 2

Farben



EXOTIC AZURE BURST [PT]

Chrome Hardware

SAS 2



EXOTIC SUNBURST [PO]

Chrome Hardware

SAS 2



EXOTIC VIOLET BURST [BPZ]

Black Brushed Hardware

SAS 2





KESELKONSTRUKTION

Maple / Walnut / Exotic Maple
 9 Lagen 7,85 mm (TT 8-10")
 9 Lagen 8,55 mm (TT/FT 12-16")
 9 Lagen 9,25 mm (BD/GD 18-24")

Birch / Walnut / Exotic Birch
 7 Lagen 6,15 mm (TT 8-10")
 7 Lagen 6,85 mm (TT/FT 12-16")
 9 Lagen 8,55 mm (BD/GD 18-24")

Saturn Evolution | Exotic Finishes

MXSE628X

Studioease Shell Set

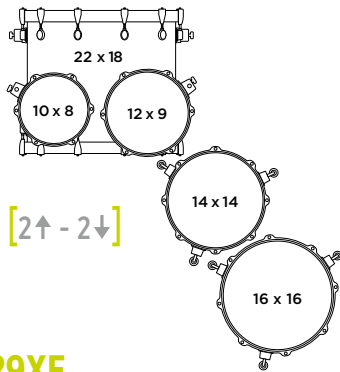

MXSE504X

Jazz Shell Set

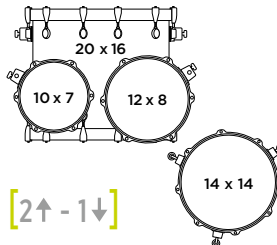

MXSE529X

Rock Shell Set

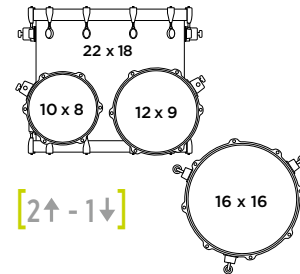

MXSE529XE

Rock Shell Set

(Fast Sizes)

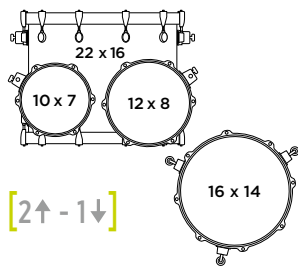

MXSE401XH

Jazz Shell Set

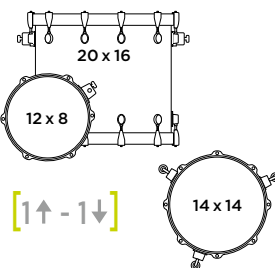

MXSE426XH

Rock Shell Set

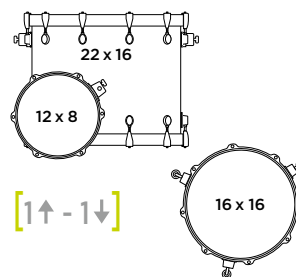

MXSE446XH

Rock Shell Set

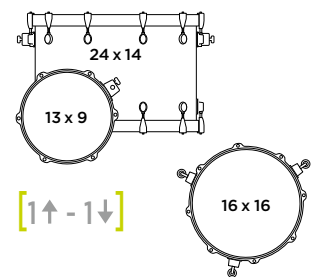

Erhältliche Farben:



Shell Sets

Bestell-Nr.	Beschreibung	EVP €
MXSE628X	Shell Set, Maple (M) od. Birch (B), bestehend aus: BD 22x18", TT 10x8", TT 12x9", FT 14x14", FT 16x16", 2x Tomhalter TH800	3.099,00
MXSE504X	Shell Set, Maple (M) od. Birch (B), bestehend aus: BD 20x16", TT 10x7", TT 12x8", FT 14x14", 2x Tomhalter TH800	2.629,00
MXSE529X	Shell Set, Maple (M) od. Birch (B), bestehend aus: BD 22x18", TT 10x8", TT 12x9", FT 16x16", 2x Tomhalter TH800	2.629,00
MXSE529XE	Shell Set, Maple (M) od. Birch (B), bestehend aus: BD 22x16", TT 10x7", TT 12x8", FT 16x14", 2x Tomhalter TH800	2.629,00
MXSE401XH	Hybrid Shell Set bestehend aus: BD 20x16" (Maple), TT 12x8" (Birch), FT 14x14" (Birch), 1x Tomhalter TH800	2.189,00
MXSE426XH	Hybrid Shell Set bestehend aus: BD 22x16" (Maple), TT 12x8" (Birch), FT 16x16" (Birch), 1x Tomhalter TH800	2.279,00
MXSE446XH	Hybrid Shell Set bestehend aus: BD 24x14" (Maple), TT 13x9" (Birch), FT 16x16" (Birch), 1x Tomhalter TH800	2.399,00



BESTELLHINWEIS

Shell Sets

Basis-Bestellnummer		Holzart z. B. M = Maple		Farbcode z. B. PO = Exotic Sunburst		Vollständige Bestellnummer
MXSE628X	+	M	+	PO	=	MXSE628XMPO

Einzeltrommeln

Basis-Bestellnummer		Holzart z. B. M = Maple		Farbcode z. B. PO = Exotic Sunburst		Vollständige Bestellnummer
MXSEB1814	+	M	+	PO	=	MXSEB1814MPO

Bass Drums

Einzeltrommeln

Bestell-Nr.	Beschreibung	EVP €
MXSEB1814	Bass Drum 18x14", ohne BD Rosette, Maple (M) od. Birch (B)	1.089,00
MXSEB2016	Bass Drum 20x16", ohne BD Rosette, Maple (M) od. Birch (B)	1.229,00
MXSEB2018	Bass Drum 20x18", ohne BD Rosette, Maple (M) od. Birch (B)	1.229,00
MXSEB2216	Bass Drum 22x16", ohne BD Rosette, Maple (M) od. Birch (B)	1.289,00
MXSEB2218	Bass Drum 22x18", ohne BD Rosette, Maple (M) od. Birch (B)	1.289,00
MXSEB2414	Bass Drum 24x14", ohne BD Rosette, Maple (M) od. Birch (B)	1.679,00
MXSEGB1816	Gong Bass Drum 18x16", Maple (M) od. Birch (B)	1.089,00

Stand Toms

Bestell-Nr.	Beschreibung	EVP €
MXSEF1412	Floor Tom 14x12", Maple (M) od. Birch (B)	599,00
MXSEF1414	Floor Tom 14x14", Maple (M) od. Birch (B)	599,00
MXSEF1614	Floor Tom 16x14", Maple (M) od. Birch (B)	629,00
MXSEF1616	Floor Tom 16x16", Maple (M) od. Birch (B)	629,00
MXSEF1816	Floor Tom 18x16", Maple (M) od. Birch (B)	669,00

Tom Toms

Bestell-Nr.	Beschreibung	EVP €
MXSET807	Tom Tom 8x7", Maple (M) od. Birch (B)	329,00
MXSET1007	Tom Tom 10x7", Maple (M) od. Birch (B)	359,00
MXSET1008	Tom Tom 10x8", Maple (M) od. Birch (B)	359,00
MXSET1208	Tom Tom 12x8", Maple (M) od. Birch (B)	379,00
MXSET1209	Tom Tom 12x9", Maple (M) od. Birch (B)	379,00
MXSET1309	Tom Tom 13x9", Maple (M) od. Birch (B)	439,00
MXSET1310	Tom Tom 13x10", Maple (M) od. Birch (B)	439,00
MXSET1410	Tom Tom 14x10", Maple (M) od. Birch (B)	579,00
MXSET1411	Tom Tom 14x11", Maple (M) od. Birch (B)	579,00



SATURN

EVOLUTION | STANDARD FINISHES



 **IRIDIUM SILVER** [PD]
Chrome Hardware

SAS 0



 **TUSCAN YELLOW** [PM]
Chrome Hardware

SAS 0



 **TUSCAN RED** [BPA]
Black Brushed Hardware

SAS 0

Farben



BRUNSWICK GREEN [PQ]

Chrome Hardware

SAS 1



PIANO BLACK [PB]

Chrome Hardware

SAS 1



GUN METAL GREY [BPG]

Black Brushed Hardware

SAS 0



POLAR WHITE [BPI]

Black Brushed Hardware

SAS 1





KESELKONSTRUKTION

Maple / Walnut / Maple

8 Lagen 7,5 mm (TT 8-10")
8 Lagen 8,2 mm (TT/FT 12-16")
8 Lagen 8,9 mm (BD/GD 18-24")

Birch / Walnut / Birch

6 Lagen 5,8 mm (TT 8-10")
6 Lagen 6,5 mm (TT/FT 12-16")
8 Lagen 8,2 mm (BD/GD 18-24")

Saturn Evolution | Standard Finishes

MXSE628X Studioease Shell Set

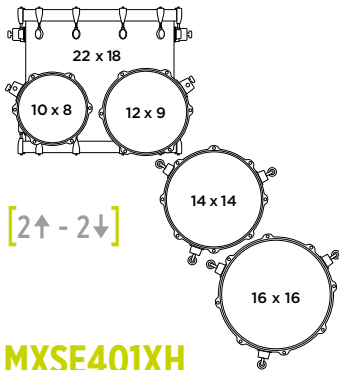

MXSE504X Jazz Shell Set

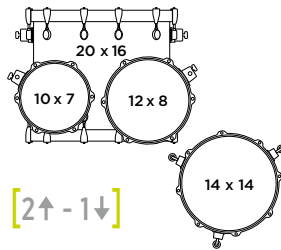

MXSE529X Rock Shell Set

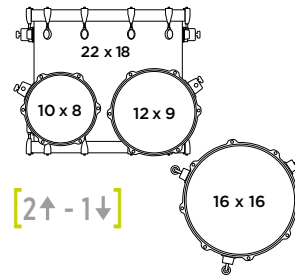

MXSE529XE Rock Shell Set (Fast Sizes)

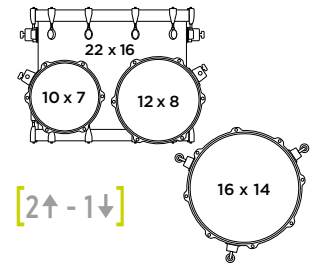

MXSE401XH Jazz Shell Set

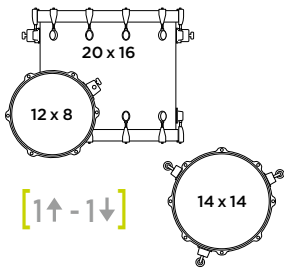

MXSE426XH Rock Shell Set

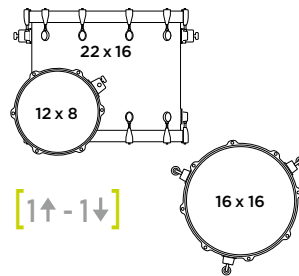

MXSE446XH Rock Shell Set

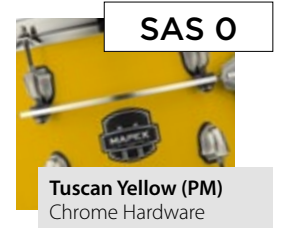
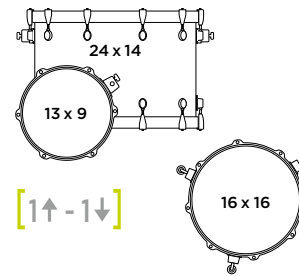

Erhältliche Farben:

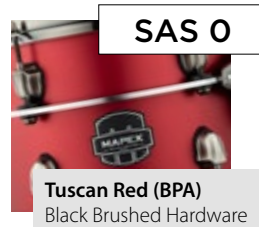
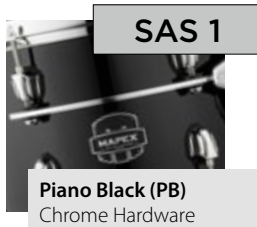
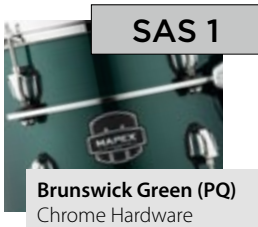

Shell Sets

Bestell-Nr.	Beschreibung	EVP €
MXSE628X	Shell Set, Maple (M) od. Birch (B), bestehend aus: BD 22x18", TT 10x8", TT 12x9", FT 14x14", FT 16x16", 2x Tomhalter TH800	2.779,00
MXSE504X	Shell Set, Maple (M) od. Birch (B), bestehend aus: BD 20x16", TT 10x7", TT 12x8", FT 14x14", 2x Tomhalter TH800	2.349,00
MXSE529X	Shell Set, Maple (M) od. Birch (B), bestehend aus: BD 22x18", TT 10x8", TT 12x9", FT 16x16", 2x Tomhalter TH800	2.349,00
MXSE529XE	Shell Set, Maple (M) od. Birch (B), bestehend aus: BD 22x16", TT 10x7", TT 12x8", FT 16x14", 2x Tomhalter TH800	2.349,00
MXSE401XH	Hybrid Shell Set bestehend aus: BD 20x16" (Maple), TT 12x8" (Birch), FT 14x14" (Birch), 1x Tomhalter TH800	1.959,00
MXSE426XH	Hybrid Shell Set bestehend aus: BD 22x16" (Maple), TT 12x8" (Birch), FT 16x16" (Birch), 1x Tomhalter TH800	1.999,00
MXSE446XH	Hybrid Shell Set bestehend aus: BD 24x14" (Maple), TT 13x9" (Birch), FT 16x16" (Birch), 1x Tomhalter TH800	2.169,00



BESTELLHINWEIS

Shell Sets

Basis-Bestellnummer		Holzart z. B. M = Maple		Farbcode z. B. PB = Piano Black		Vollständige Bestellnummer
MXSE628X	+	M	+	PB	=	MXSE628XMPB

Einzeltrommeln

Basis-Bestellnummer		Holzart z. B. M = Maple		Farbcode z. B. PB = Piano Black		Vollständige Bestellnummer
MXSEB1814	+	M	+	PB	=	MXSEB1814MPB

Bass Drums

Einzeltrommeln

Bestell-Nr.	Beschreibung	EVP €
MXSEB1814	Bass Drum 18x14", ohne BD Rosette, Maple (M) od. Birch (B)	939,00
MXSEB2016	Bass Drum 20x16", ohne BD Rosette, Maple (M) od. Birch (B)	1.069,00
MXSEB2018	Bass Drum 20x18", ohne BD Rosette, Maple (M) od. Birch (B)	1.069,00
MXSEB2216	Bass Drum 22x16", ohne BD Rosette, Maple (M) od. Birch (B)	1.119,00
MXSEB2218	Bass Drum 22x18", ohne BD Rosette, Maple (M) od. Birch (B)	1.119,00
MXSEB2414	Bass Drum 24x14", ohne BD Rosette, Maple (M) od. Birch (B)	1.529,00
MXSEGB1816	Gong Bass Drum 18x16", Maple (M) od. Birch (B)	939,00

Stand Toms

Bestell-Nr.	Beschreibung	EVP €
MXSEF1412	Floor Tom 14x12", Maple (M) od. Birch (B)	549,00
MXSEF1414	Floor Tom 14x14", Maple (M) od. Birch (B)	549,00
MXSEF1614	Floor Tom 16x14", Maple (M) od. Birch (B)	579,00
MXSEF1616	Floor Tom 16x16", Maple (M) od. Birch (B)	579,00
MXSEF1816	Floor Tom 18x16", Maple (M) od. Birch (B)	619,00

Tom Toms

Bestell-Nr.	Beschreibung	EVP €
MXSET807	Tom Tom 8x7", Maple (M) od. Birch (B)	289,00
MXSET1007	Tom Tom 10x7", Maple (M) od. Birch (B)	329,00
MXSET1008	Tom Tom 10x8", Maple (M) od. Birch (B)	329,00
MXSET1208	Tom Tom 12x8", Maple (M) od. Birch (B)	349,00
MXSET1209	Tom Tom 12x9", Maple (M) od. Birch (B)	349,00
MXSET1309	Tom Tom 13x9", Maple (M) od. Birch (B)	399,00
MXSET1310	Tom Tom 13x10", Maple (M) od. Birch (B)	399,00
MXSET1410	Tom Tom 14x10", Maple (M) od. Birch (B)	509,00
MXSET1411	Tom Tom 14x11", Maple (M) od. Birch (B)	509,00

SATURN

SO YOU THINK YOU KNOW SATURN? THINK AGAIN.

Saturn – der Klassiker lebt!

Der einzigartige Saturn Sound trifft auf Design Lab Features. Die Kesselkonstruktion bei der neuen **Saturn Serie** bleibt wie sie ist. Design Lab Features und neue Finishes verleihen dem Klassiker aber einen neuen und moderneren Charakter.



SAS Static 90° Floor Tom Leg

Umso gerader das Bein, desto größer der Soundverlust:
Das 90° Design Lab Floortom Bein löst genau dieses
Problem.

SAS Sonic Pedestal Foot

Die Konstruktion des Fußes verhindert den direkten Kontakt zum Boden, was die Floortom auf der Gummifeder zum „schweben“ bringt. Das eliminiert den Verlust durch Vibrationsübertragung und maximiert die Kesselresonanz.





Floor Tom Isolation Gaskets

Alle Metallteile der Floortomhalterungen befinden sich vollständig an der Außenseite des Kessels und sind durch eine spezielle Gummilftdichtung isoliert. Dadurch wird der gesamte Druck vom Kessel genommen und der Vibrationsverlust maximal verringert.

Air Flow Venting

Die Ventilation ist der Schlüssel zum Spielgefühl und der Eigenresonanz des Kessels. Bei ausführlichen Tests bei den Design Lab Drums wurde nach einer Formel für die ideale Anzahl von Luftlöchern geforscht.

Diese werden an der „Nodal Line“ zusammen mit den Böckchen angebracht, um die Resonanz des Kessels nicht negativ zu beeinflussen.

Air Vents

TT/FT	2
BD	4

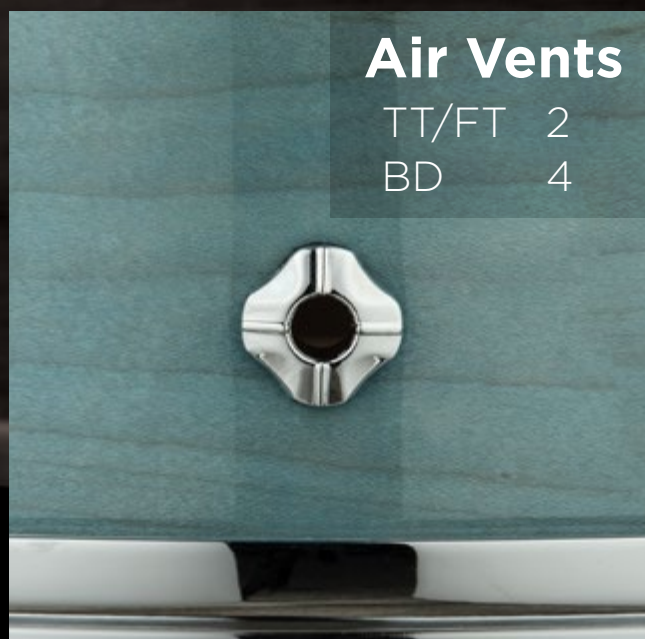

SAS Scale Finishes

SAS 0

Hat einen sehr geringen bis keinen Einfluss auf den Sound des Kessels.

SAS 1

Hat einen geringen Einfluss auf den Sound des Kessels.





SATURN

SERIE

⊕ SATIN BLACK [FB]

SAS 0

⊕ TEAL BLUE FADE [RJ]

SAS 1

⊕ SCARLET FADE [RQ]

SAS 1



Farben

⊕ **SATIN WHITE** [RM]

SAS 0

⊕ **AQUA FADE** [UQ]

SAS 1

⊕ **SULPHUR FADE** [UJ]

SAS 1



KESSELKONSTRUKTION

Walnut / Maple / Maple
 6 Lagen 5,8 mm (TT/FT 12-16")
 6 Lagen 7,2 mm (BD/GD 18-24")

MXSR628X Studioease Shell Set

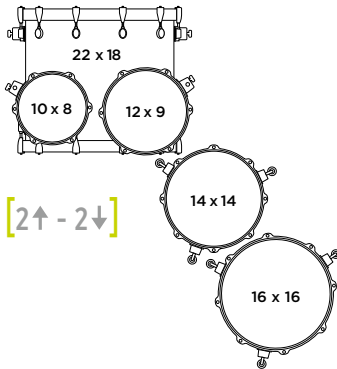

MXSR628XU Studioease Shell Set

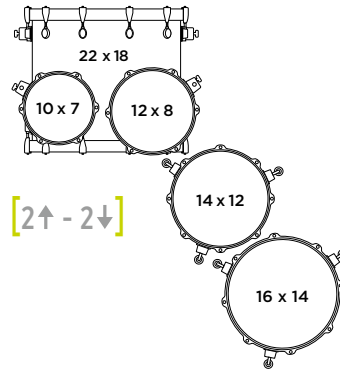

MXSR529X Rock Shell Set

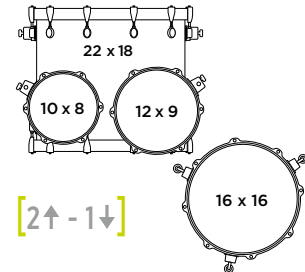

Erhältliche Farben:



MXSR529XU Rock Shell Set (Fast Sizes)

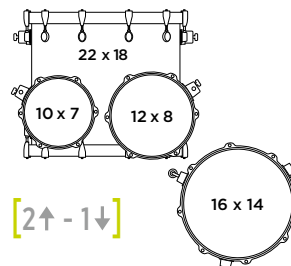

MXSR504X Jazz Shell Set

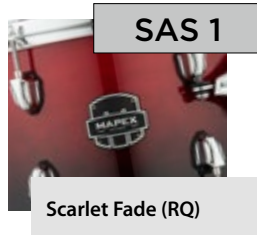
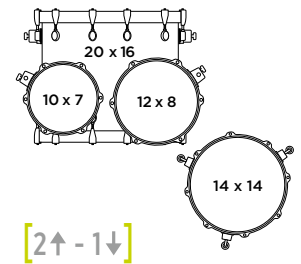

Shell Sets

Bestell-Nr.	Beschreibung	EVP €
MXSR628X	Shell Set bestehend aus: BD 22x18", TT 10x8", TT 12x9", FT 14x14", FT 16x16", 2x Tomhalter TH800	2.199,00
MXSR628XU	Shell Set bestehend aus: BD 22x18", TT 10x7", TT 12x8", FT 14x12", FT 16x14", 2x Tomhalter TH800	2.199,00
MXSR529X	Shell Set bestehend aus: BD 22x18", TT 10x8", TT 12x9", FT 16x16", 2x Tomhalter TH800	1.799,00
MXSR529XU	Shell Set bestehend aus: BD 22x18", TT 10x7", TT 12x8", FT 16x14", 2x Tomhalter TH800	1.799,00
MXSR504X	Shell Set bestehend aus: BD 20x16", TT 10x7", TT 12x8", FT 14x14", 2x Tomhalter TH800	1.799,00

i Die Saturn Serie ist ausschließlich mit Chrome Hardware erhältlich.



TUNE LESS
PLAY MORE
 MIT SONICLEAR™ BEARING EDGE

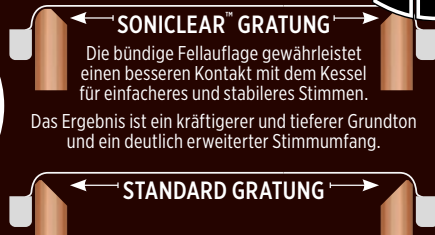

Bass Drums

Einzeltrommeln

Bestell-Nr.	Beschreibung	EVP €
MXSRB1814A	Bass Drum 18x14", ohne BD Rosette	749,00
MXSRB2016A	Bass Drum 20x16", ohne BD Rosette	849,00
MXSRB2018A	Bass Drum 20x18", ohne BD Rosette	849,00
MXSRB2216A	Bass Drum 22x16", ohne BD Rosette	889,00
MXSRB2218A	Bass Drum 22x18", ohne BD Rosette	889,00
MXSRB2414A	Bass Drum 24x14", ohne BD Rosette	979,00
MXSRGB1816	Gong Bass Drum 18x16"	749,00

Stand Toms

Bestell-Nr.	Beschreibung	EVP €
MXSRF1412	Floor Tom 14x12"	439,00
MXSRF1414	Floor Tom 14x14"	439,00
MXSRF1614	Floor Tom 16x14"	459,00
MXSRF1616	Floor Tom 16x16"	459,00
MXSRF1816	Floor Tom 18x16"	499,00

Tom Toms

Bestell-Nr.	Beschreibung	EVP €
MXSRT807	Tom Tom 8x7"	229,00
MXSRT1007	Tom Tom 10x7"	269,00
MXSRT1008	Tom Tom 10x8"	269,00
MXSRT1208	Tom Tom 12x8"	279,00
MXSRT1209	Tom Tom 12x9"	279,00
MXSRT1309	Tom Tom 13x9"	319,00
MXSRT1310	Tom Tom 13x10"	319,00

Snares

Bestell-Nr.	Beschreibung	EVP €
MXSRS4650	Snare 14x6,5"	399,00



ARMORY

SERIE



⊕ NIGHT SKY BURST [CVL]



⊕ RAINFOREST BURST [CET]



⊕ EMERALD BURST [CFG]

Farben



+ NEU ARCTIC WHITE [OW]



+ ULTRAMARINE [CUM]



+ NEU PIANO BLACK [PB]



+ DESERT DUNE [DW]



+ REDWOOD BURST [CRA]

Armory Serie



KESSELKONSTRUKTION

Birch / Maple / Birch Hybrid
7,2 mm, 6 Lagen
lackiert

MXAR628F

Studioease Shell Set

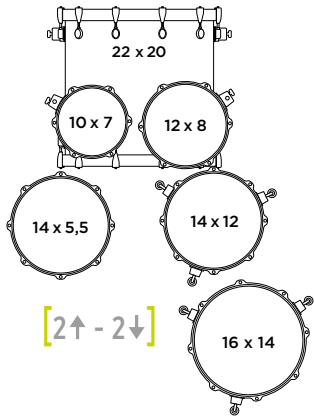

MXAR628S

Studioease Shell Set

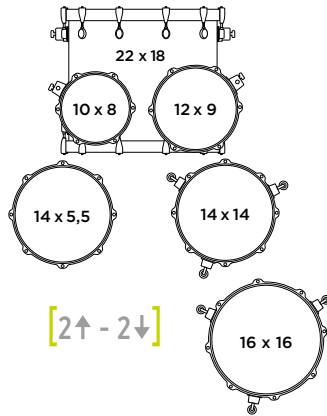

MXAR529S

Rock Shell Set

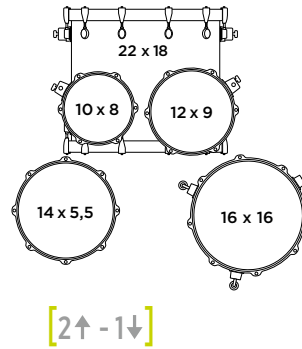

MXAR504S

Jazz Shell Set

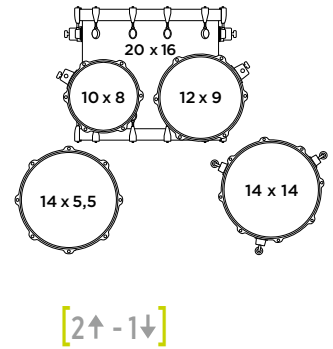

Erhältliche Farben:

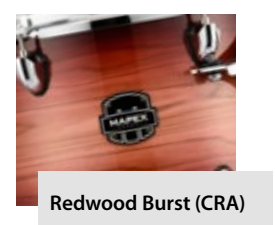
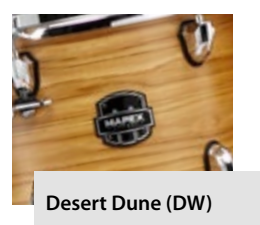
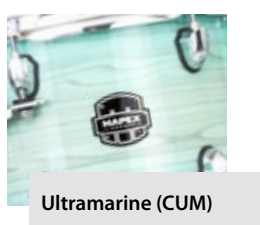
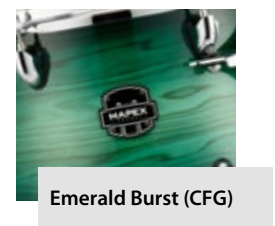

Shell Sets

Bestell-Nr.	Beschreibung	EVP €
MXAR628F	Shell Set bestehend aus: BD 22x20" (ohne Rosette), TT 10x7", TT 12x8", FT 14x12", FT 16x14", ARMORY Tomahawk 14x5,5" Steel Snare, Tomhalter TH800	1.299,00
MXAR628S	Shell Set bestehend aus: BD 22x18" (ohne Rosette), TT 10x8", TT 12x9", FT 14x14", FT 16x16", ARMORY Tomahawk 14x5,5" Steel Snare, Tomhalter TH800	1.299,00
MXAR529S	Shell Set bestehend aus: BD 22x18" (ohne Rosette), TT 10x8", TT 12x9", FT 16x16", ARMORY Tomahawk 14x5,5" Steel Snare, Tomhalter TH800	1.099,00
MXAR504S	Shell Set bestehend aus: BD 20x16" (ohne Rosette), TT 10x8", TT 12x9", FT 14x14", ARMORY Tomahawk 14x5,5" Steel Snare, Tomhalter TH800	1.099,00

i Die Armory Serie ist ausschließlich mit Chrome Hardware erhältlich.



TUNE LESS
PLAY MORE
 MIT SONICLEAR™ BEARING EDGE

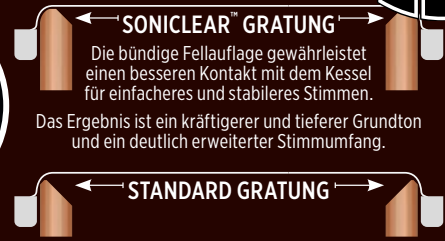



MARS

MAPLE

Farben



⊕ **MATTE BLACK** [KD]



⊕ **NATURAL SATIN** [NW]



⊕ **MIDNIGHT BLUE** [OD]



⊕ **GLOSSY AMBER** [OG]

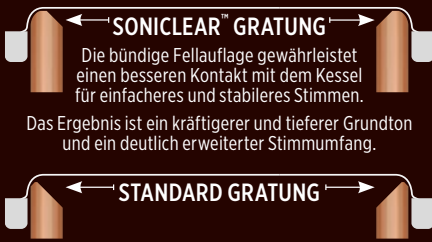

KESELKONSTRUKTION

Maple

100% European Maple 7 Lagen, 7,2 mm

FEATURES

SONIClear™ Bearing Edge
SONIClear™ Suspension System
Insulated Bass Drum Claws
Matching Snare Drum
Bass Drum Mounted Tom Holders



MXMA486S:

Inklusive Bass Drum Lifter

MXMM628SFU Rock Shell Set

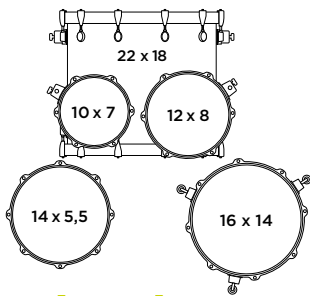

[2↑ - 1↓]

MXMM529SF Rock Shell Set

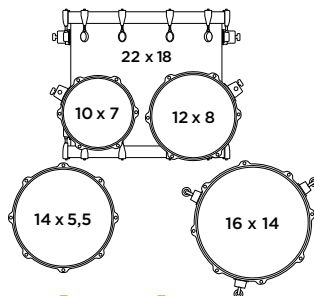

[2↑ - 1↓]

MXMM504SF Jazz Shell Set

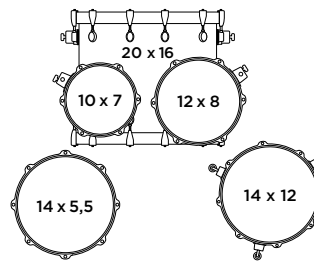

[2↑ - 1↓]

MXMM486S Jazz Shell Set

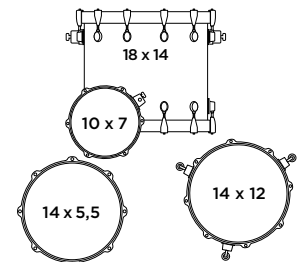

[1↑ - 1↓]

Erhältliche Farben:

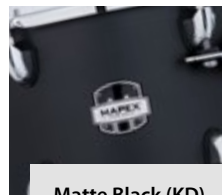

Matte Black (KD)

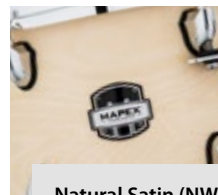

Natural Satin (NW)



Midnight Blue (OD)

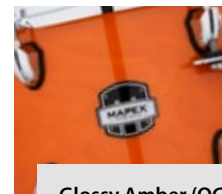

Glossy Amber (OG)

Shell Sets

Bestell-Nr.	Beschreibung	EVP €
MXMM628SFU	Shell Set bestehend aus: BD 22x18", TT 10x7", TT 12x8", FT 14x12", FT 16x14", SD 14x5,5", Tomhalter TH676	1.149,00
MXMM529SF	Shell Set bestehend aus: BD 22x18", TT 10x7", TT 12x8", FT 16x14", SD 14x5,5", Tomhalter TH676	979,00
MXMM504SF	Shell Set bestehend aus: BD 20x16", TT 10x7", TT 12x8", FT 14x12", SD 14x5,5", Tomhalter TH676	979,00
MXMM486S	Shell Set bestehend aus: BD 18x14", TT 10x7", FT 14x12", SD 14x5,5", Tomhalter TH683 und Bass Drum Lifter MBL909	849,00

Die Mars Serie ist ausschließlich mit Chrome Hardware erhältlich.



MARS

BIRCH

Farben



⊕ DIAMOND SPARKLE [DT]

⊕ TWILIGHT SPARKLE [MI]

⊕ SUNFLOWER SPARKLE [YD]

⊕ BLOOD ORANGE SPARKLE [OR]

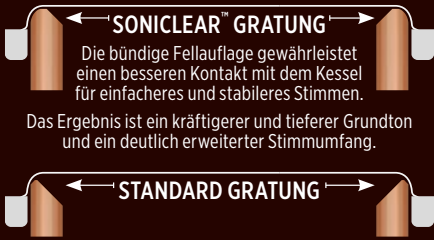

KESSELKONSTRUKTION

Birch
100% Birch 6 Lagen, 7,2 mm foliert

FEATURES

SONIClear™ Bearing Edge
SONIClear™ Suspension System
Matching Snare Drum

+ **MXMA486S:**
Inklusive Bass Drum Lifter

MXMA529SF Rock Shell Set

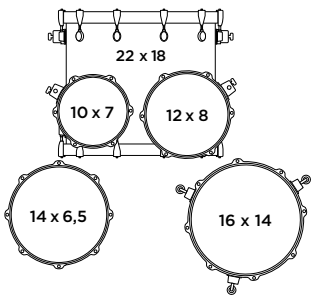

[2↑ - 1↓]

MXMA528SF Rock Shell Set

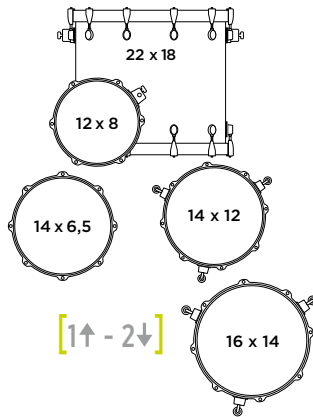

[1↑ - 2↓]

MXMA486S Jazz Shell Set

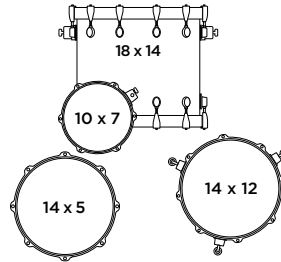

[1↑ - 1↓]

MXMA446S Rock Shell Set

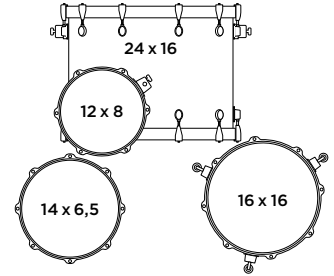

[1↑ - 1↓]

Erhältliche Farben:



Diamond Sparkle (DT)



Twilight Sparkle (MI)

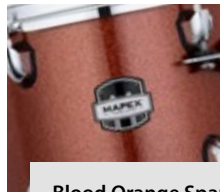

Blood Orange Sparkle (OR)



Sunflower Sparkle (YD)

Shell Sets

Bestell-Nr.	Beschreibung	EVP €
MXMA529SF	Shell Set bestehend aus: BD 22x18", TT 10x7", TT 12x8", FT 16x14", SD 14x6,5" Tomhalter TH676	739,00
MXMA528SF	Shell Set bestehend aus: BD 22x18" (ohne Rosette), TT 12x8", FT 14x12", FT 16x14", SD 14x6,5" Tomhalter TH800	739,00
MXMA486S	Shell Set bestehend aus: BD 18x14", TT 10x7", FT 14x12", SD 14x5" Tomhalter TH683, 6705-075A und Bass Drum Lifter MBL909	679,00
MXMA446S	Shell Set bestehend aus: BD 24x16" (ohne Rosette), TT 12x8", FT 16x16", SD 14x6,5" Tomhalter TH800	749,00

i Die Mars Serie ist ausschließlich mit Chrome Hardware erhältlich.



VENUS

SERIE



⊕ **STEEL BLUE METALLIC** [VC]



⊕ **BLACK GALAXY SPARKLE** [VH]



⊕ **BLUE SKY SPARKLE** [VI]

UPD

Farben



 **AQUA BLUE SPARKLE** [VJ]



 **CRIMSON RED SPARKLE** [VM]

ATE



 **COPPER METALLIC** [VX]



KESSELKONSTRUKTION

Poplar
7,2 mm, 9 Lagen, foliert



UPDATE

VENUS SERIE

Jetzt inklusive zweitem B400 Beckenständer und wahlweise 3-teiligem MAPEX oder 3-teiligem ZILDJIAN Planet Z Beckensatz

MXVE5045

Jazz Konfiguration

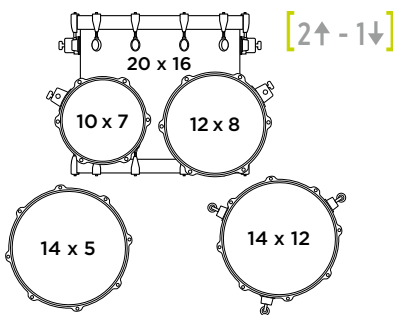

MXVE5295

Rock Konfiguration

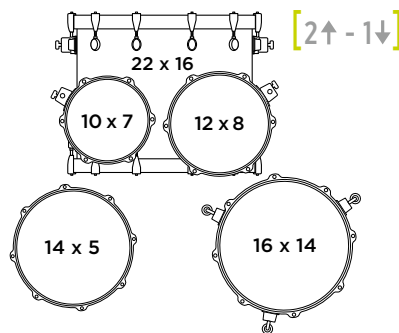

Erhältliche Farben:



Steel Blue Metallic (VC)



Black Galaxy Sparkle (VH)



Aqua Blue Sparkle (VJ)



Blue Sky Sparkle (VI)



Crimson Red Sparkle (VM)



Copper Metallic (VX)

Pappelkessel

9-lagige, 7,2mm starke Kessel aus Pappel für einen vollen, warmen Sound.

SONIClear™ Bearing Edge

Das SONIClear Bearing Edge erlaubt dem Fell einen perfekten Sitz und somit besseren Kontakt zu den Kesseln. Das Ergebnis ist ein tieferer Grundton, eine riesige Tuning Range und ein deutlich einfacheres Stimmen.

REMO® UC Drumheads

Das Schlagzeugfell ist eines der wichtigsten Elemente, die sich massiv auf den Klang auswirken. Deshalb ist die Venus Serie standardmäßig mit REMO® Fellen ausgestattet.

Mini B-Lug

Das Design ist ganz klar von dem der Saturn Evolution Series inspiriert.

TH652 Double Tom Holder

Einfache Funktionalität trifft Vielseitigkeit.

Die Venus Serie wird in sechs aufregenden Farben angeboten.



Die Venus Serie ist ausschließlich mit Chrome Hardware erhältlich.



Neue Messing-Becken...

...die diese Bezeichnung auch verdienen. Ein sehr dynamisches 20" Ride, 16" Crash und 14" HiHats, die in dieser Preisklasse ihres gleichen suchen, runden das Gesamtbild der Komplett-Sets ab.



Komplett-Sets

Bestell-Nr.	Beschreibung	EVP €
UPDATE MXVE5295FTCVC	Komplett Drum Set bestehend aus: BD 22x16", TT 10x7", TT 12x8", FT 16x14", SN 14x5", 2x B400, S400, H410, P410, T400, Doppeltomhalter TH656 und 3-teiligem MAPEX Beckenset	599,00
UPDATE MXVE5045FTCVC	Komplett Drum Set bestehend aus: BD 20x16", TT 10x7", TT 12x8", FT 14x12", SN 14x5", 2x B400, B200, S400, H410, P410, T400, Doppeltomhalter TH656 und 3-teiligem MAPEX Beckenset	599,00

Pro Packs



inkl. **Zildjian**
Planet Z Complete
Pack (14" HiHat,
16" Crash, 20" Ride)

Bestell-Nr.	Beschreibung	EVP €
UPDATE MXVE5295FTZ	Pro Pack bestehend aus: BD 22x16", TT 10x7", TT 12x8", FT 16x14", SN 14x5", 2x B400, S400, H410, P410, T400, Doppeltomhalter TH656 und 3-teiligem ZILDJIAN Beckenset	799,00
UPDATE MXVE5045FTZ	Pro Pack bestehend aus: BD 20x16", TT 10x7", TT 12x8", FT 14x12", SN 14x5", 2x B400, B200, S400, H410, P410, T400, Doppeltomhalter TH656 und 3-teiligem ZILDJIAN Beckenset	799,00



NEU

COMET

SERIE



+ DARK BLACK [DK]

Farben



 **INDIGO BLUE** [IB]



 **INFRA RED** [IR]



KESSELKONSTRUKTION

Poplar
7,2 mm, 6 Lagen
foliert



SONICLEAR™ GRATUNG

Die bündige Fellaufgabe gewährleistet einen besseren Kontakt mit dem Kessel für einfacheres und stabileres Stimmen. Das Ergebnis ist ein kräftigerer und tieferer Grundton und ein deutlich erweiterter Stimmumfang.

STANDARD GRATUNG

NEU

COMET SERIE

Wahlweise mit **2-teiligem MAPEX** oder **3-teiligem ZILDJIAN Planet Z Beckensatz**

MXCM584* Jazz Konfiguration

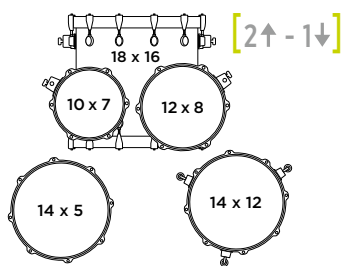

MXCM504* Jazz Konfiguration

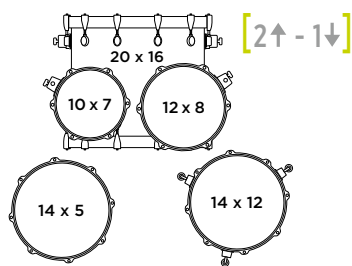

MXCM529* Rock Konfiguration

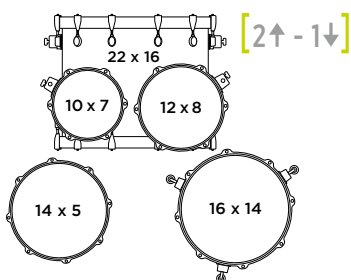

Erhältliche Farben:



Dark Black (DK)



Indigo Blue (IB)

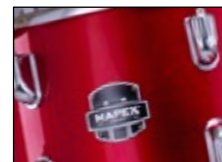

Infra Red (IR)

Neue 250er Hardware

Fußmaschine und HiHat sind mit den aus der 400er Serie bekannten MAPEX Fußplatten und alle Stative mit großen und komfortablen Wingnuts ausgestattet.



Lieferung inklusive einem kompletten Hardwarepack, bestehend aus:

MXC250 Beckenständer, MXS250 Snareständer,
MXP250 Fußmaschine, MXH250 HiHat Maschine,
MXT400 Drumhocker

Die Comet Serie ist ausschließlich mit Chrome Hardware erhältlich.





Neue Messing-Becken...

...die diese Bezeichnung auch verdienen. Ein sehr dynamisches 16" Crash und 14" HiHats, die in dieser Preisklasse ihres gleichen suchen, runden das Gesamtbild der Komplett-Sets ab.



Komplett-Sets

Bestell-Nr.	Beschreibung	EVP €
NEU MXCM5294FTC	Komplett Drum Set bestehend aus: BD 22x16", TT 10x7", TT 12x8", FT 16x14", SD 14x5" inkl. 4-teiligem Hardware Pack, Hocker, 14" Hats, 16" Crash	499,00
NEU MXCM5044FTC	Komplett Drum Set bestehend aus: BD 20x16", TT 10x8", TT 12x9", FT 14x14", SD 14x5" inkl. 4-teiligem Hardware Pack, Hocker, 14" Hats, 16" Crash	499,00
NEU MXCM5844FTC	Komplett Drum Set bestehend aus: BD 18x16", TT 10x7", TT 12x8", FT 14x12", SD 14x5" inkl. 4-teiligem Hardware Pack, Hocker, 14" Hats, 16" Crash	499,00

Pro Packs

Bestell-Nr.	Beschreibung	EVP €
NEU MXCM5295FTZ	Pro Pack bestehend aus: BD 18x16", TT 10x7", TT 12x8", FT 14x12", SD 14x5" inkl. 5-teiligem Hardware Pack, Hocker, Zildjian Planet Z Beckenset	699,00
NEU MXCM5045FTZ	Pro Pack bestehend aus: BD 20x16", TT 10x8", TT 12x9", FT 14x14", SD 14x5" inkl. 5-teiligem Hardware Pack, Hocker, Zildjian Planet Z Beckenset	699,00
NEU MXCM5845FTZ	Pro Pack bestehend aus: BD 22x16", TT 10x7", TT 12x8", FT 16x14", SD 14x5" inkl. 5-teiligem Hardware Pack, Hocker, Zildjian Planet Z Beckenset	699,00



inkl. **Zildjian Planet Z Complete Pack** (14" HiHat, 16" Crash, 20" Ride)



inkl. zusätzl. **MXB250**

BLACK PANTHER designLAB

Die Ultra-Premium Snare Drums des MAPEX Black Panther Design Lab

Das Black Panther Design Lab-Konzept spiegelt die enge Zusammenarbeit internationaler Top-Drummer wider. Das Ergebnis sind Instrumente, die den strengen Anforderungen an Sound, Funktionalität und Dynamik gerecht werden. Mit dem Verständnis, wie unterschiedliche Tonhölzer, Gratungen, das Profil der Spannreifen, Böckchenformen, Snareteppiche, Felle und sogar die Lackierung den Sound einer Trommel beeinflussen, gelang es MAPEX mit einem neuen Soundkonzept einzigartige und ultra-professionelle High-End Snares zu erschaffen.



BLACK PANTHER CHERRY BOMB

BPCW3550CNW - 13x5,5"
BPCW4600CNW - 14x6"



KESSELKONSTRUKTION

8 Lagen / 9 mm Cherry

BLACK PANTHER HEARTBREAKER



BPMH460LNW - 14x6"



KESSELKONSTRUKTION

8 Lagen 8 mm Mahogany
4 Lagen 4 mm Mahogany Reinforcement Rings



BLACK PANTHER EQUINOX

BPML4500CFB- 14x5"



KESSELKONSTRUKTION

6 Lagen 6 mm Maple / 4 Lagen 4 mm Maple Reinforcement Rings

Bestell-Nr.	Beschreibung	EVP €
BPCW3550CNW	Design Lab, 13x5,5", Natural Satin Wood, „Cherry Bomb“	499,00
BPCW4600CNW	Design Lab, 14x6", Natural Satin Wood, „Cherry Bomb“	499,00
BPMH460LNW	Design Lab, 14x6", Natural Satin Wood, „Heartbreaker“	589,00
BPML4500CFB	Design Lab, 14x5", Flat Black Maple Burl, „Equinox“	669,00

BLACK PANTHER
 design**LAB**
**ARTIST
SNARES**
The Versatus | Russ Miller

Kesselkonstruktion
 2,75 Maple
 1,7 *2-Mahogany
 2,4 Maple (8,55 mm)

 BPDLMH4460LPW **14 x 4,625"**

 BPDLMH4650LPW **14 x 6,5"**

The Maximus | Jeff Hamilton

Kesselkonstruktion
 2,4 Mahogany
 1,7 Mahogany
 2,4 *2-Mahogany
 (8,9 mm)

 BPDLMH4600LPB **14 x 6"**

**The Warbird |
Chris Adler**

Kesselkonstruktion
 1,7 Maple
 1,7 Walnut
 1,7 Walnut (5,1 mm)



BPDLMW2550LWH

12 x 5,5"

The Machine | Craig Blundell

Kesselkonstruktion
 1,7 Walnut | 2,4 Maple
 2,4 Maple (6,5 mm)

 BPDLMW4550LNW **14 x 5,5"**

Bestell-Nr.	Beschreibung	EVP €
BPDLMH4460LPW	Design Lab Artist Snare, 14x4,625", Maple/Mahogany/Maple, Peach Burl Burst, „The Versatus“	869,00
BPDLMH4650LPW	Design Lab Artist Snare, 14x6,5", Maple/Mahogany/Maple, Peach Burl Burst, „The Versatus“	939,00
BPDLMH4600LPB	Design Lab Artist Snare, 14x6", Mahogany/Mahogany/Mahogany, Gloss Piano Black, „The Maximus“	939,00
BPDLMW4550LNW	Design Lab Artist Snare, 14x5,5", Walnut/Maple/Maple, Satin Natural over Walnut, „The Machine“	869,00
BPDLMW2550LWH	Design Lab Artist Snare, 12x5,5", Maple/Walnut/Walnut, Satin Natural over Walnut, „The Warbird“	779,00

WOOD



GOBLIN 12x5,5“

BPNWN2550LXN

Kesselkonstruktion
6-lagig 5,1 mm Walnuss



HYDRO 13x7“

BPNML3700LFB

Kesselkonstruktion
6-lagig 5,1 mm Ahorn |
4 Lagen 4 mm
Walnuss Verstärkungsringe



NUCLEUS 14 x 5,5“

BPNMW4550CPB

Kesselkonstruktion
8-lagig 8,1 mm
Ahorn/Walnuss/Ahorn



SCORPION 14x5,5“

BPNMH4550CNX

Kesselkonstruktion
8-lagig 8,9 mm Mahagoni



PEGASUS 14x5,5“

BPNMW4550LXN

Kesselkonstruktion
7-lagig 6,15 mm Ahorn/Walnuss



SHADOW 14x6,5“

BPNBW4650CXN

Kesselkonstruktion
7-lagig 6,85 mm Birke/Walnuss



RAZOR 14x5“

BPNML4500CGD

Kesselkonstruktion
6-lagig 6,0 mm Ahorn



SOLIDUS 14x7“

BPNML4700CVD

Kesselkonstruktion
11-lagig, 11 mm Ahorn



HERITAGE 14x6“

BPNML4600CWD

Kesselkonstruktion
5-lagig 5,0 mm Ahorn | 4 Lagen 4 mm
Walnuss Verstärkungsringe



VENOM 14x5“

BPNML4550COW

Kesselkonstruktion
8-lagig 6,85 mm Ahorn

Bestell-Nr.	Beschreibung	EVP €
BPNMH4550CNX	14x5,5, Mahagoni, Red Sand Strata, „Scorpion“	439,00
BPNWN2550LXN	12x5,5, Walnut, Natural Walnut, „Goblin“	419,00
BPNML3700LFB	13x7“, Maple/Walnut/Maple, Satin Black, „Hydro“	479,00
BPNMW4550CPB	14x5,5“, Maple/Walnut/Maple, Polished Black, „Nucleus“	449,00
BPNML4500CGD	14x5“, Maple, Dark Grey, „Razor“	379,00
BPNMW4550LXN	14x5,5“, Walnut/Maple, Natural Maple Burl, „Pegasus“	529,00
BPNBW4650CXN	14x6,5“, Birch/Walnut, Natural Maple Burl, „Shadow“	399,00
BPNML4550COW	14x5“, Maple, Arctic White, „Venom“	419,00
BPNML4700CVD	14x7“, Maple, Brown Red Burst, „Solidus“	529,00
BPNML4600CWD	14x6“, Maple, White Pricobloc Pearl, „Heritage“	359,00

BLACK PANTHER

SNARE PROGRAM

METAL



 **PERSUADER** 14 x 6,5“
BPNBR465HCN
Kesselkonstruktion
1,2 mm gehämmertes Messing



 **PREDATOR** 14 x 6“
BPNCO4601CN
Kesselkonstruktion
1,2 mm Kupfer



 **METALLION** 14 x 5,5“
BPNBR4551CN
Kesselkonstruktion
1,2 mm Messing



 **ATOMIZER** 14 x 6,5“
BPNAL4651CN
Kesselkonstruktion
2,0 mm Aluminium



 **CYRUS** 14 x 6“
BPNST4601CN
Kesselkonstruktion
1,0 mm Stahl



 **WASP** 10 x 5,5“
BPNST0551CN
Kesselkonstruktion
1,0 mm Stahl

Bestell-Nr.	Beschreibung	EVP €
BPNBR465HCN	14x6,5“, Hammered Brass, „Persuader“	599,00
BPNCO4601CN	14x6“, Copper, „Predator“	569,00
BPNBR4551CN	14x5,5“, Brass, „Metallion“	479,00
BPNAL4651CN	14x6,5“, Aluminium, „Atomizer“	569,00
BPNST4601CN	14x6“, Steel, „Cyrus“	389,00
BPNST0551CN	10x5,5“, Steel, „Wasp“	369,00



SONICS MATTER FIND YOUR SOUND

THE MPX SERIES SNARE DRUMS



Ahorn/Pappel Hybrid Kessel
sorgen für einen warmen
Vintage Sound



Piston Strainer
Snareabhebung



Low Mass W-Lug
Böckchen



Maple/Poplar Hybrid
Transparent Midnight Black #MB

Bestell-Nr.	Beschreibung	EVP €
MXMPNMP4800BMB	14x8"	169,00
MXMPNMP4650BMB	14x6,5"	159,00
MXMPNMP4550BMB	14x5,5"	159,00
MXMPNMP4350BMB	13x3,5"	149,00
MXMPNMP3600BMB	13x6"	149,00
MXMPNMP2600BMB	12x6"	149,00
MXMPNMP0550BMB	10x5,5"	149,00

**Kesselkonstruktion**

Maple/Poplar, 7,2 mm, lackiert
Stahl, 1 mm

**Steel / Chrome**

Bestell-Nr.	Beschreibung	EVP €
MXMPNST4651CN	14x6,5"	159,00
MXMPNST4551CN	14x5,5"	159,00
MXMPNST4351CN	14x3,5"	149,00
MXMPNST0551CN	10x5,5"	139,00

**Maple/Poplar Hybrid
Gloss Natural #NL**

Bestell-Nr.	Beschreibung	EVP €
MXMPNMP4800CNL	14x8"	169,00
MXMPNMP4650CNL	14x6,5"	159,00
MXMPNMP4550CNL	14x5,5"	159,00
MXMPNMP4350CNL	13x3,5"	149,00
MXMPNMP3600CNL	13x6"	149,00
MXMPNMP2600CNL	12x6"	149,00
MXMPNMP0550CNL	10x5,5"	149,00

Hardware

ARMORY

MXHP8005



Black Finish
(MXHP8005EB)

MARS

MXHP6005



Black Finish
(MXHP8005EB)

FALCON

MXHPF1000



COMET

MXHP2505



Hardware Packs

Bestell-Nr.	Beschreibung	EVP €
MXHPF1000	Falcon Hardware Pack, bestehend aus: 2x MXB800 Boom Stand, MXHF1000 Hihat Stand, MXSF1000 Snare Stand, MXPF1000 Bass Drum Pedal, Chrome Finish	879,00
MXHP8005	Armory Hardware Pack, bestehend aus: 2x MXB800 Boom Stand, MXH800 Hihat Stand, MXS800 Snare Stand, MXP800 Bass Drum Pedal, Chrome Finish	559,00
MXHP8005EB	Armory Hardware Pack, bestehend aus: 2x MXB800 Boom Stand, MXH800 Hihat Stand, MXS800 Snare Stand, MXP800 Bass Drum Pedal, Black Finish	589,00
MXHP6005	Mars Hardware Pack, bestehend aus: 2x MXB600 Boom Stand, MXH600 Hihat Stand, MXS600 Snare Stand, MXP600 Bass Drum Pedal, Chrome Finish	399,00
MXHP6005EB	Mars Hardware Pack, bestehend aus: 2x MXB600 Boom Stand, MXH600 Hihat Stand, MXS600 Snare Stand, MXP600 Bass Drum Pedal, Black Finish	415,00
NEU MXHP2505	Comet Hardware Pack, bestehend aus: MXC250 Cymbalstand, MXB250 Boom Stand, MXH250 Hihat Stand, MXS250 Snare Stand, MXP250 Bass Drum Pedal, Chrome Finish	199,00

Fußmaschinen

MXPF1000



MXPF1000TW



Bestell-Nr.	Beschreibung	EVP €
MXPF1000	Falcon, Doppelkette, Filzbeater mit austauschbarem Gewicht, Bodenplatte	265,00
MXPF1000TW	Falcon, Doppelkette, Filzbeater mit austauschbarem Gewicht, Bodenplatte	529,00
MXPF1000LTW	Falcon, Doppelkette, Filzbeater mit austauschbarem Gewicht, Bodenplatte, Linksversion	529,00

MXP810



MXP810TW



Bestell-Nr.	Beschreibung	EVP €
MXP810	Armory, Response Drive, Doppelkette, Filzbeater mit austauschbarem Gewicht, Bodenplatte, inkl. Gigbag	169,00
MXP810TW	Armory, Response Drive, Doppelkette, Filzbeater mit austauschbarem Gewicht, Bodenplatte, inkl. Gigbag	329,00

MXP600



MXP600TW



Bestell-Nr.	Beschreibung	EVP €
MXP600	Mars, Doppelkette, Filzbeater, Bodenplatte	95,00
MXP600TW	Mars, Doppelkette, Filzbeater, Bodenplatte	239,00

MXP410



MXP410TW



Bestell-Nr.	Beschreibung	EVP €
MXP410	Venus, Einzelkette, Falcon Beater, Bodenplatte	69,00
MXP410TW	Venus, Einzelkette, Falcon Beater, Bodenplatten	175,00



MXP250



Bestell-Nr.	Beschreibung	EVP €
MXP250	Comet, Einzelkette, Filzbeater	39,00

NEU



MXHF1000



MXH800



MXH600EB



MXH410



MXH410EB



MXH250

HiHats

Bestell-Nr.	Beschreibung	EVP €
MXHF1000	Falcon, Direct Pull Spring System, doppelstrebig, Chrome Finish	279,00
MXH800	Armory, Tru Direct Pull Drive System, doppelstrebig, Beine drehbar, Chrome Finish	159,00
MXH800EB	Armory, Tru Direct Pull Drive System, doppelstrebig, Beine drehbar, Black Finish	169,00
MXH600	Mars, Direct Chain Drive, doppelstrebig, Chrome Finish	119,00
MXH600EB	Mars, Direct Chain Drive, doppelstrebig, Black Finish	125,00
MXH410	Venus, Direct Chain Drive, doppelstrebig, Chrome Finish	95,00
MXH410EB	Venus, Direct Chain Drive, doppelstrebig, Black Finish	99,00
NEU MXH250	Comet, Direct Chain Drive, doppelstrebig, Chrome Finish	55,00



MXSF1000



MXS800EB



MXS600



MXS400



MXS400EB



MXS250

Snareständer

Bestell-Nr.	Beschreibung	EVP €
MXSF1000	Falcon, extra tief einstellbar, stufenlos neigbar, für 10"-15" Snares, Chrome Finish	139,00
MXS800	Armory, stufenlos neigbar, doppelstrebig, Chrome Finish	95,00
MXS800EB	Armory, stufenlos neigbar, doppelstrebig, Black Finish	99,00
MXS600	Mars, Zahnsegmentschrägsteller, doppelstrebig, Chrome Finish	89,00
MXS600EB	Mars, Zahnsegmentschrägsteller, doppelstrebig, Black Finish	85,00
MXS400	Venus, Zahnsegmentschrägsteller, doppelstrebig, Chrome Finish	65,00
MXS400EB	Venus, Zahnsegmentschrägsteller, doppelstrebig, Black Finish	75,00
NEU MXS250	Comet, Zahnsegmentschrägsteller, doppelstrebig, Chrome Finish	49,00

Cymbal-/ Boom- ständer

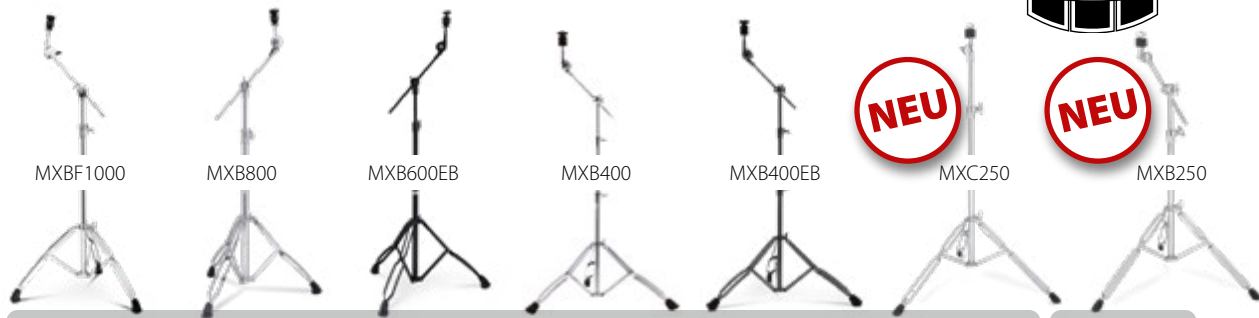

Bestell-Nr.	Beschreibung	EVP €
MXBF1000	Falcon, 2-fach ausziehbar, ein Galgen, Chrome Finish	159,00
MXB800	Armory, stufenlos neigbar, versenkbarer Galgen, doppelstrebig, Chrome Finish	115,00
MXB800EB	Armory, stufenlos neigbar, versenkbarer Galgen, doppelstrebig, Black Finish	119,00
MXB600	Mars, Zahnsegmentschrägsteller, versenkbarer Galgen, doppelstrebig, Chrome Finish	85,00
MXB600EB	Mars, Zahnsegmentschrägsteller, versenkbarer Galgen, doppelstrebig, Black Finish	85,00
MXB400	Venus, 2-fach ausziehbar, ein Galgen, Chrome Finish	65,00
MXB400EB	Venus, 2-fach ausziehbar, ein Galgen, Black Finish	75,00
NEU MXC250	Comet, gerade Ausführung, Chrome Finish	39,00
NEU MXB250	Comet, 1-fach ausziehbar, ein Galgen, Chrome Finish	45,00

Kombinationsständer

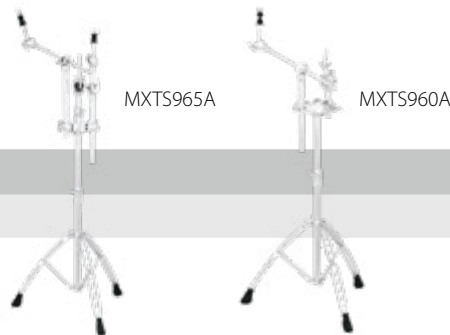

Bestell-Nr.	Beschreibung	EVP €
MXTS965A	1-fach ausziehbar, mit 1x TH684, 1x B75	275,00
MXTS960A	1-fach ausziehbar, mit 1x TH684, 1x B75	229,00

Tomständer



Bestell-Nr.	Beschreibung	EVP €
MXTS950A	1-fach ausziehbar, mit 2x TH684	219,00
MXTS701	1-fach ausziehbar, mit 1x TH676	185,00

Cymbalhalter



Bestell-Nr.	Beschreibung	EVP €
MXB100	Falcon Galgenbeckenarm, Rohrdurchmesser 7/8", Chrome Finish	89,00
MXB80	Armory Galgenbeckenarm mit Falcon Quick Release, Rohrdurchmesser 3/4", Chrome Finish	69,00
MXB80EB	Armory Galgenbeckenarm mit Falcon Quick Release, Rohrdurchmesser 3/4", Black Finish	75,00
MXB60	Mars Galgenbeckenarm, Rohrdurchmesser 3/4", Chrome Finish	39,00
MXB60EB	Mars Galgenbeckenarm, Rohrdurchmesser 3/4", Black Finish	45,00
MXCH72	Closed HiHat zur Montage per Multiklammer oder am Rack, Chrome Finish	109,00

Drummer- sitze



MXT875



MXT870



MXT865



MXT865SER



MXT855



MXT850

800 SERIES DRUM THRONES

STAY GROUNDED. STAY COOL.

Der neu entwickelte atmungsaktive Sitz des T855BR & T855BL bietet eine optimale Luftzirkulation für das ultimative Spielerlebnis.

Jetzt in den Farben Blau und Braun erhältlich.

NEU

T855BL



MXT855BR

NEU

T855BR



MXT855BL

Bestell-Nr.	Beschreibung	EVP €
MXT875	Sattelsitz, Spindel, Höhe 48-67 cm, mit Rückenlehne	255,00
MXT870	Runder Sitz, Spindel, Höhe 48-67 cm, mit Rückenlehne	255,00
MXT865	Sattelsitz, Stoffbezug schwarz, Spindel, Höhe 46-66 cm	209,00
MXT865SER	Sattelsitz, Stoffbezug rot, Spindel, Höhe 46-66 cm	209,00
NEU MXT855BR	Sattelsitz, Stoffbezug braun, Spindel, Höhe 48-64 cm	199,00
NEU MXT855BL	Sattelsitz, Stoffbezug blau, Spindel, Höhe 48-64 cm	199,00
MXT855	Sattelsitz, Spindel, Höhe 46-66 cm	199,00
MXT850	Runder Sitz, Spindel, Höhe 46-66 cm	199,00

COMFORT MEETS ENDURANCE

600 SERIES DRUM THRONES

Die **600er Serie** erhält dreifachen Zuwachs. Die **neuen Modelle T675A, T680 und T685** bieten Stabilität und maximalen Komfort bei jeder Spielintensität.

NEU T685
SCHWARZES
STOFFBERTEIL



NEU T680
BEQUEM
UND ROBUST



NEU T675A
WEICHER
VINYLBEZUG



400 & 200 SERIES DRUM THRONES

Bestell-Nr.	Beschreibung	EVP €
NEU MXT685	Sattelsitz, Stoffbezug, Spindel, Höhe 41-62 cm	139,00
NEU MXT680	Runder Sitz, Stoffbezug, Spindel, Höhe 41-62 cm	125,00
NEU MXT675A	Sattelsitz, Höhenverst. Memory Lock, Höhe 41-62 cm	125,00
MXT670	Runder Sitz, Höhenverst. Memory Lock, Höhe 41-62 cm	95,00
MXT660	Runder Sitz, Spindel, Memory Lock, Höhe 41-62 cm	95,00
MXT400	Runder Sitz, 6-Step mit Flügelmutter, Höhe 44-56 cm	49,00
MXT270A	Runder Sitz, 6-Step mit Flügelmutter, Höhe 44-56 cm	69,00

Tomhalte- arme



MXMSSTC



MXTH653



MXTH692



MXTH676

Bestell-Nr.	Beschreibung	EVP €
MXMSSTC	SONIClear Single Tom Klammer, Chrome Finish	48,00
MXMSSTCEB	SONIClear Single Tom Klammer, Black Finish	49,00
MXMSSTCBC	SONIClear Single Tom Klammer, Black Chrome Finish	56,00
MXTH653	Single Tomhalter, stufenlos neigbar, 7/8" Rohr, Chrome Finish	85,00
MXTH692	Doppeltomhalter für Saturn IV Serie, 1" Rohr, Chrome Finish	159,00
MXTH692B	Doppeltomhalter für Saturn IV Serie, 1" Rohr, Black Chrome Finish	239,00
MXTH676	Doppeltomhalter für Armory, Mars Serie, stufenlos neigbar, 1" Rohr, Chrome Finish	155,00
MXTH676EB	Doppeltomhalter für Armory, Mars Serie, stufenlos neigbar, 1" Rohr, Black Finish	169,00
MXTH656	Doppeltomhalter für Storm Serie, stufenlos neigbar, 1" Rohr, Chrome Finish	119,00



MXMC902



MXMC903



MXMTH908



MXMBL909

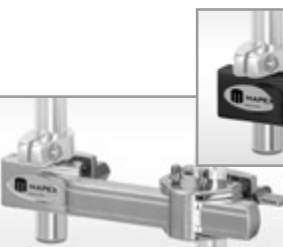

MXMC910 (Aluminium)



MXMC910EB (Black)



MXMCH912



MXMCH913



MX6705-075A

Multiklammern & Adapter

Bestell-Nr.	Beschreibung	EVP €
MXMC902	Multiklammer mit zwei Drehgelenken	35,00
MXMC903	Multiklammer lang, mit zwei Drehgelenken	39,00
MXMTH908	Multiklammer für zwei Cymbal-/Tomhaltearme	35,00
MXMBL909	Lifter für 18" und 20" Bass Drum	22,00
MXMC910	Multiklammer, längeverstellbar	26,00
MXMC910EB	Multiklammer, längeverstellbar, Black	29,00
MXMCH912	Multiklammer zur Befestigung einer Cowbell/Accessories an der Bass Drum	20,00
MXMCH913	Multiklammer zur Befestigung einer Cowbell/Accessories am Ständer	37,00
MX6705-075A	7/8" auf 1" Adapter zur Befestigung eines Becken- oder Tomarms an eine Bass Drum Rosette	17,00

Accessories

Stimmschlüssel



Bestell-Nr.	Beschreibung	EVP €
MPKZWA059	Vierkantschlüssel Chrome	2,00

Sonic Saver Spannreifen



MP471410

Bestell-Nr.	Beschreibung	EVP €
MP471308	13" Spannreifen Chrome	59,00
MP4713081	13" Spannreifen Chrome, Snare Side	59,00
MP471308BB	13" Spannreifen Black Brushed	89,00
MP4713081BB	13" Spannreifen Black Brushed, Snare Side	89,00
MP471410	14" Spannreifen Chrome	65,00
MP4714101	14" Spannreifen Chrome, Snare Side	65,00
MP471410BB	14" Spannreifen Black Brushed	99,00
MP4714101BB	14" Spannreifen Black Brushed, Snare Side	99,00
MP471410AB	14" Spannreifen Brass Brushed	99,00
MP4714101AB	14" Spannreifen Brass Brushed, Snare Side	99,00



MPACDD



MXMBW10



MPACSD



MXMBW20



MPACBP

Fußmaschinen Accessories

Bestell-Nr.	Beschreibung	EVP €
MPACDD	Direct Drive für PF1000, PF1000TW	75,00
MPACSD	Strap Drive für PF1000, PF1000TW	19,00
MPACBP	Falcon Beater inkl. Gewichte (10g, 20g)	35,00
MXMBW10	Falcon Beater Gewicht 10g	7,00
MXMBW20	Falcon Beater Gewicht 20g	7,00



MPACCHC



MPACCHN



MP2680-346A

HiHat Accessories

Bestell-Nr.	Beschreibung	EVP €
MPACCHC	Clutch mit Quick Release für alle gängigen HiHat Maschinen	25,00
MPACCHN	Quick Release für alle gängigen HiHat Clutches	15,00
MP2680-346A	Clutch für H950A, H750A, H550A und H350A	15,00



MPB1000618A



MP3481-355X



MP3480-355X

Cymbal- & Boomständer Accessories

Bestell-Nr.	Beschreibung	EVP €
MPB1000618A	Quick Release Beckenhalter M8 für alle gängigen Beckenständer	5,00
MP3481-355X	Multi Sustain Beckenfilz	4,00
MP3480-355X	Gummis zur Beckenaufnahme	3,00

Snare Drum Teppiche



MP1S584850A



MP1S582850

Bestell-Nr.	Beschreibung	EVP €
MP1S584850A	für 10" Snares, 16 Spiralen, Chrome, Stainless Steel	20,00
MP1S582850	für 10" Snares, 16 Spiralen, Chrome	10,00
MP1A394850	für 12" Snares, 20 Spiralen, Chrome	10,00
MP1K396850A	für 13" Snares, 20 Spiralen, Chrome, Stainless Steel	20,00
MP1K394850	für 13" Snares, 20 Spiralen, Chrome	10,00
MP18794850	für 14" Snares, 20 Spiralen, Chrome	10,00
MP1F6W0850	für 13" Snares, 42 Spiralen, Chrome	22,00

Bassdrum Sticker

KTMXSTBDWH



KTMXSTBDBL

Bestell-Nr.	Beschreibung	EVP €
KTMXSTBDWH	MAPEX Bass Drum Sticker weiß - geplottet, für dunklen Untergrund	6,00
KTMXSTBDBL	MAPEX Bass Drum Sticker schwarz - geplottet, für hellen Untergrund	6,00

Gigbags

Sets



Gigbag Set für Shellsets –
verschiedene Konfigurationen

Bestell-Nr.	Beschreibung	EVP €
MXDBS504S	MAPEX Taschen, Gigbag Set für Shellset, 20x18"/10x9"/12x10"/14x14"/14x5,5"	115,00
MXDBS522S	MAPEX Taschen, Gigbag Set für Shellset, 22x18"/10x8"/12x9"/14x11"/14x5,5"	115,00
MXDBS524S	MAPEX Taschen, Gigbag Set für Shellset, 22x18"/10x8"/12x9"/14x14"/14x5,5"	115,00
MXDBS628S	MAPEX Taschen, Gigbag Set für Shellset, 22x18"/10x8"/12x9"/14x14"/16x16"/14x5,5"	149,00
MXDBS529S	MAPEX Taschen, Gigbag Set für Shellset, 22x18"/10x8"/12x9"/16x16"/14x5,5"	129,00
MXDBS525S	MAPEX Taschen, Gigbag Set für Shellset, 22x18"/12x9"/13x10"/16x16"/14x5,5"	129,00

Einzeltrummeln

Bestell-Nr.	Beschreibung	EVP €
MXDB808	MAPEX Tasche, Gigbag für Tom Tom 8x8"	14,00
MXDB108	MAPEX Tasche, Gigbag für Tom Tom 10x8"	15,00
MXDB120	MAPEX Tasche, Gigbag für Tom Tom 12x10"	17,00
MXDB131	MAPEX Tasche, Gigbag für Tom Tom 13x10"	18,00
MXDB141	MAPEX Tasche, Gigbag für Tom Tom 14x10"	19,00
MXDB144	MAPEX Tasche, Gigbag für Floor Tom 14x14"	29,00
MXDB1455	MAPEX Tasche, Gigbag für Snare 14x5,5"	19,00
MXDB166	MAPEX Tasche, Gigbag für Floor Tom 16x16"	29,00
MXDB186	MAPEX Tasche, Gigbag für Floor Tom oder Bass Drum 18x16"	29,00
MXDB206	MAPEX Tasche, Gigbag für Bass Drum 20x16"	39,00
MXDB228	MAPEX Tasche, Gigbag für Bass Drum 22x18"	39,00
MXDB220	MAPEX Tasche, Gigbag für Bass Drum 22x20"	39,00
MXDB242	MAPEX Tasche, Gigbag für Bass Drum 24x20"	39,00

Cymbals / Sticks / Hardware



MXPMKM116



MXPMKM117



MXPMKM113

Bestell-Nr.	Beschreibung	EVP €
MXPMKM116	Cymbalbag schwarz mit Logo	69,00
MXPMKM117	Stickbag schwarz mit Logo und Schultergurt	19,00
MXPMKM113	für Hardware, schwarz mit Logo und Rollen	109,00

Student Percussion Kits

BELL KIT

MXMPK32PC



SNARE KIT

MXMSK14DC



COMBO KIT

MXMCK1432DP



Bestell-Nr.	Beschreibung	EVP €
MXMPK32PC	Glockenspiel mit Zubehör und Trolley	259,00
MXMSK14DC	Snare Kit mit Zubehör und Trolley	229,00
MXMCK1432DP	Glockenspiel - 14x3,5" Snare Kombi mit Zubehör und Trolley	369,00

Postanschrift:

MUSIK MEYER GmbH
MUSIK & TECHNIK
Industriestraße 20
35041 Marburg

Der Verkauf erfolgt ausschließlich über den Musikinstrumentenfachhandel. Der angegebene empfohlene Verkaufspreis versteht sich inkl. der gesetzlich vorgeschriebenen MwSt. Preis- und Modelländerungen ohne Vorankündigung vorbehalten. Keine Haftung für Irrtümer oder Druckfehler.